

**Canon**

**EOS**

**REBEL / REBEL**  
**2000 / 2000**

**DATE**

**300 / 300 DATE**

The image was removed due to copyright restrictions.

**E**

English Edition  
**Instructions**

THE IMAGE WAS REMOVED DUE  
TO COPYRIGHT RESTRICTIONS

# Thank you for purchasing a Canon product.

The EOS REBEL 2000/EOS 300 is a very compact autofocus, single-lens reflex camera. It can be used for a wide variety of subjects and situations with fully automatic and user-controlled picture-taking modes.

Read this Instructions booklet and familiarize yourself with your new camera before taking pictures.

## ■ Symbols



The Caution symbol alerts you to actions to prevent picture-taking problems.



The Note symbol gives additional information for basic camera operation.



The Lightbulb symbol offers helpful tips for operating your camera and taking pictures.

Page numbers in parentheses indicate where you can find more relevant information.

Also read "Handling Precautions" on page 6 to prevent camera malfunction and damage.

In this Instructions booklet, the EF 28-80mm f/3.5-5.6 II lens is shown in illustrations for explanatory purposes.

## Keep this Instructions booklet handy for easy reference.

### ■ Precautions

- Before using the camera for an important event, be sure to take test shots to make sure the camera operates properly.
- EOS cameras have a lens mount for dedicated operation (autofocusing, exposure control, etc.) with EF lenses. Using a non-EF lens with an EOS camera may not result in proper camera or lens operation.

Note that the warranty does not cover any camera malfunction or damage occurring with the use of non-Canon accessories.







# Contents

Handling Precautions.....	6
Quick Start Guide .....	8
Nomenclature .....	10

## 1 Before You Start .....15



Attaching the Strap .....	15
Installing the Batteries and Checking the Battery Level .....	16
Mounting and Detaching a Lens .....	18
How the Shutter Button Works .....	19
Loading and Unloading Film .....	20
 Midroll Film Rewind.....	21
Holding the Camera.....	22

## 2 Camera-Controlled Automatic Shooting .....23

<input type="checkbox"/> Full Auto Mode .....	24
Automatic Flash Firing of the Built-in Flash.....	26
AF-Assist with the Built-in Flash.....	26
Single-frame and Continuous Shooting.....	26
 Using Red-eye Reduction .....	27
 Portrait Mode .....	28
 Landscape Mode .....	29
 Close-up Mode .....	30
 Sports Mode .....	31
 Night Scene Mode .....	32
 Self-timer Operation .....	33
Using the Eyepiece Cover.....	34
Imprinting the Date or Time (QD Model only) .....	35
Setting the Date and Time.....	36
Replacing the Quartz Date Back's Battery .....	36

## 3 User-Controlled Shooting .....37

Focusing Point Selection .....	38
Focusing Subjects not Covered by the Focusing Points .....	39
When Autofocus Fails (Switching to Manual Focus) .....	40
Metering Modes .....	41
<b>P</b> Program AE .....	42
The Difference Between <b>P</b> and <input type="checkbox"/> .....	43
About Program Shift.....	43

<b>Tv</b> Shutter-Speed Priority AE .....	44
<b>Av</b> Aperture-Priority AE .....	46
Depth-of-field Preview .....	47
<b>M</b> Manual Exposure .....	48
<b>A-DEP</b> Automatic Depth-of-Field AE .....	50
* Partial Metering Using AE Lock .....	51
Exposure Compensation .....	52
 Auto Exposure Bracketing (AEB) .....	53
••) Silencing the Beeper .....	54
Bulb Exposures .....	55
 Multiple Exposures .....	56
<b>ISO</b> Setting the ISO Film Speed .....	57
Using the Remote Switch (Sold separately) .....	58

## **4 Using the Built-in Flash.....59**

Using the Built-in Flash .....	60
--------------------------------	----

## **Reference Section .....62**

Basic Photography Terms .....	62
Feature Availability Table .....	64
AF Modes and Film Advance Modes .....	64
Exposure Warnings .....	65
Troubleshooting Guide .....	66
Major Accessories (Sold separately) .....	67
Specifications .....	69
Index .....	72

1

2

3

4

Reference

# Handling Precautions

## Camera Care

- (1) This camera is not waterproof and cannot be used in rain or under water. If the camera gets really wet, promptly consult your nearest Canon Service Center. If there are any water droplets on the camera, wipe off with a dry cloth. If the camera has been exposed to salt air, wipe with a clean, well-wrung, damp cloth.
- (2) Do not leave the camera in places prone to excessive heat such as in a car on a sunny day. Excessive heat can cause the camera to malfunction.
- (3) Use only a blower brush to remove any dust on the lens or in the film compartment. Do not use a cleaner containing organic solvent to clean the camera body or lens. For stubborn dirt, consult your nearest Canon Service Center.
- (4) When you will not be using the camera for an extended period, remove the batteries. Store the camera in a well-ventilated, cool, dry place. Release the shutter a few times occasionally to make sure the camera still works.
- (5) Avoid storing the camera in a laboratory, cabinet, etc., where corrosive chemicals are present.
- (6) Before using the camera after an extended period of disuse, check that all the camera controls function properly or take it to the nearest Canon Service Center for inspection. Do this especially before shooting an important event or going on a trip.

## LCD Panel

In time, the camera's LCD panel display may fade and become difficult to read. If this happens, have it replaced (at cost) by a Canon Service Center. At low temperatures, the LCD panel's display response may become slower. And at 60°C or higher temperatures, the display may blacken. In either case, the display will return to normal at room temperature.

## Lithium Batteries

- (1) The camera operates on two CR2 lithium batteries. Check the battery level in the following cases:
  - After replacing the batteries.
  - After not using the camera for an extended period.
  - The shutter stops working.
  - The camera is being used in a low-temperature environment.
  - You will be shooting an important event.
- (2) Before installing the batteries, wipe the battery contacts to remove any fingerprints and smudges. This is to prevent faulty connections and corrosion.
- (3) Although the batteries work well even at low temperatures, battery performance may decline slightly at freezing temperatures. In such a case, keep spare batteries warm in a pocket, etc., and use and warm the batteries alternately.

## How Low Battery Levels Affect Camera Operation

Even when  blinks on the LCD panel, a proper exposure will be obtained as long as the shutter releases. However, since the battery level is low, film advance and auto rewind may not work. Replace the batteries with new ones.

## Lens

After detaching the lens from the camera, put on the lens caps or put down the lens with the rear end up to avoid scratching the lens surface and electrical contacts.

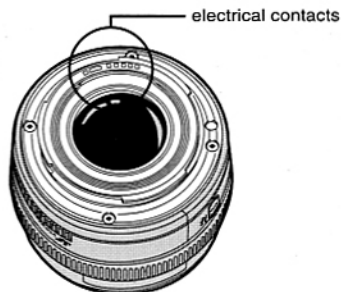

# Quick Start Guide

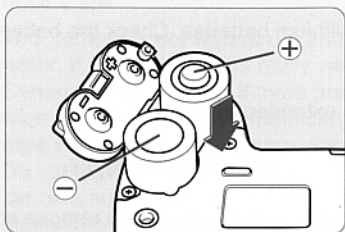

## 1 Install the batteries.

Insert two CR2 lithium batteries as shown by the battery orientation diagram on the battery chamber cover. See page 16.

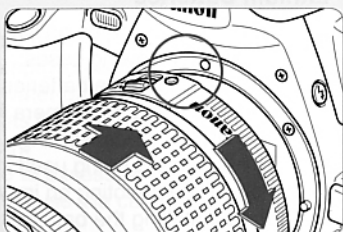

## 2 Attach a lens.

Align the red dots on the lens and camera and turn the lens clockwise until it snaps in place. See page 18.

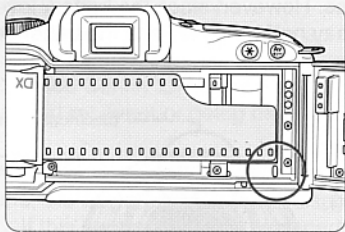

## 5 Load the film.

Align the edge of the film leader with the orange mark on the camera and close the camera back until it snaps shut. See page 20.

- The film will then advance to the first frame automatically.

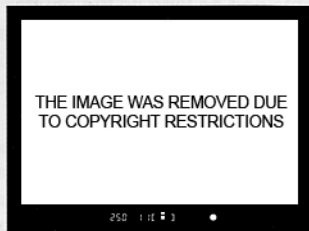

## 6 Focus the subject.

Aim the AF frame on the subject and press the shutter button halfway to autofocus. See page 24.

- Under low-light or backlit conditions, the built-in flash will fire automatically. See page 60.



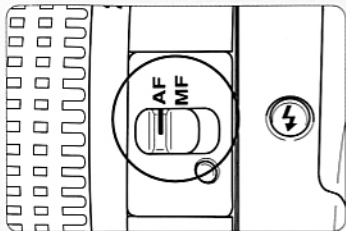

### 3 On the lens, set the focus mode switch to AF.

See page 18.

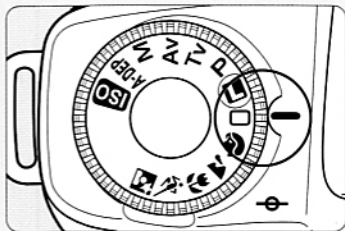

### 4 Turn the Command Dial to <math>\square</math> (Full Auto).

See page 24.

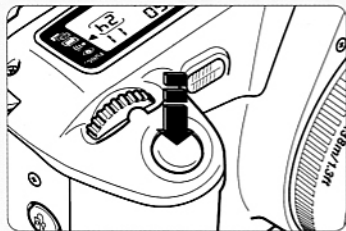

### 7 Take the picture.

Press the shutter button completely to take the picture.  
See page 19.

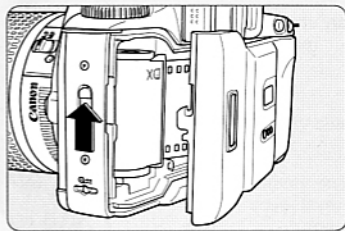

### 8 Unloading the film.

At the end of the roll, the film rewinds automatically. Open the camera back and remove the film cartridge. See page 21.

# Nomenclature

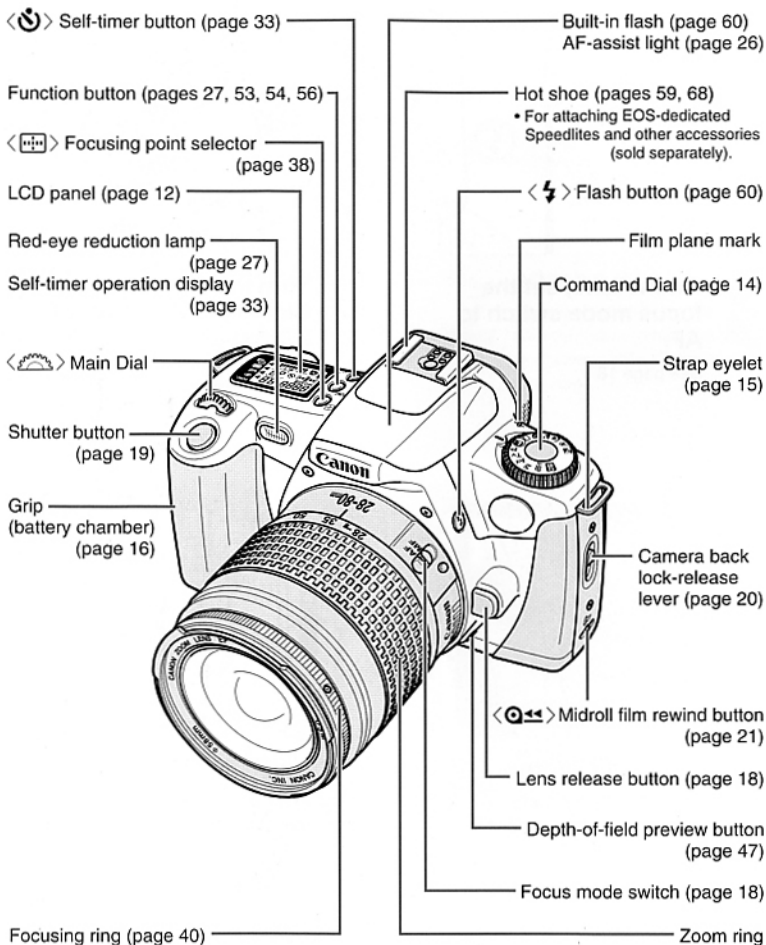

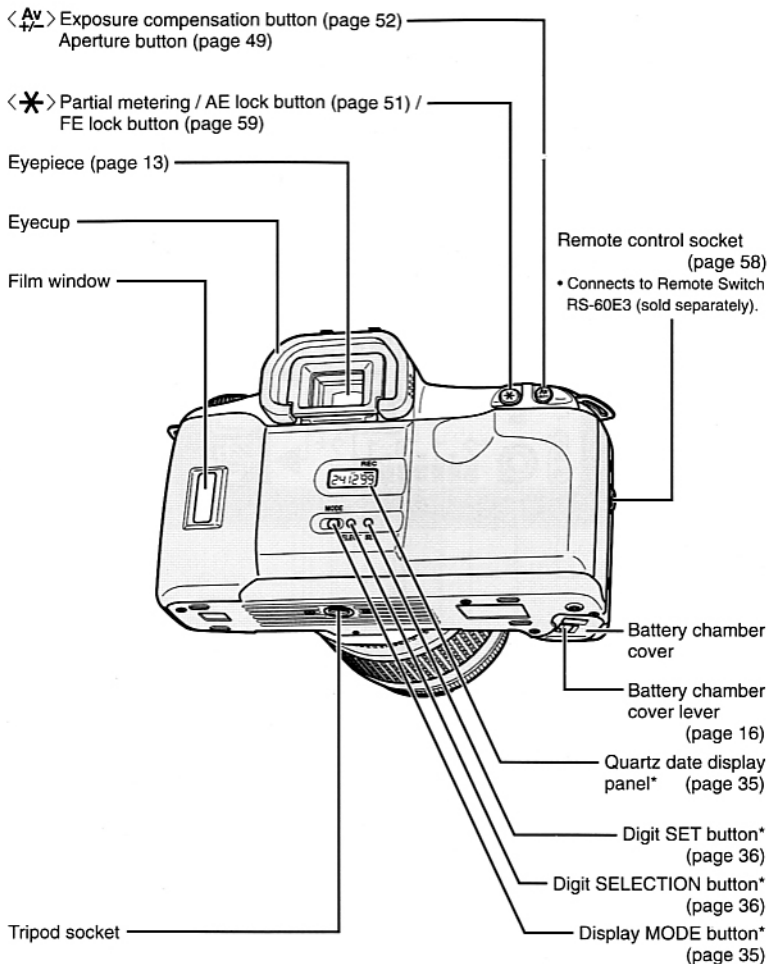

\* QD model only.

## LCD Panel

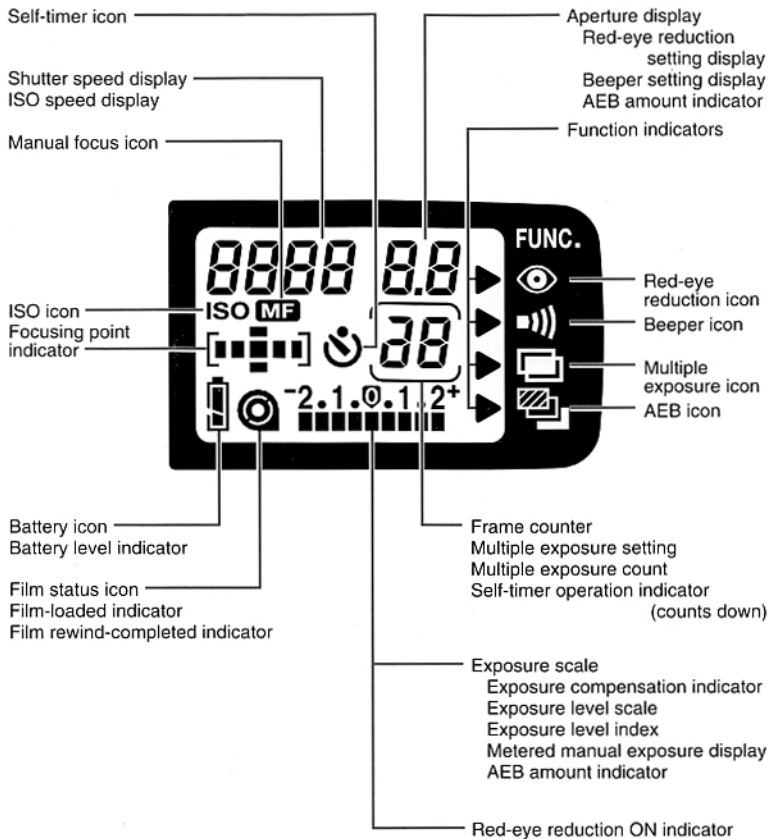

The LCD panel is shown with all the information displayed. The actual information displayed will vary depending on the camera settings and shooting conditions.

## Viewfinder Information

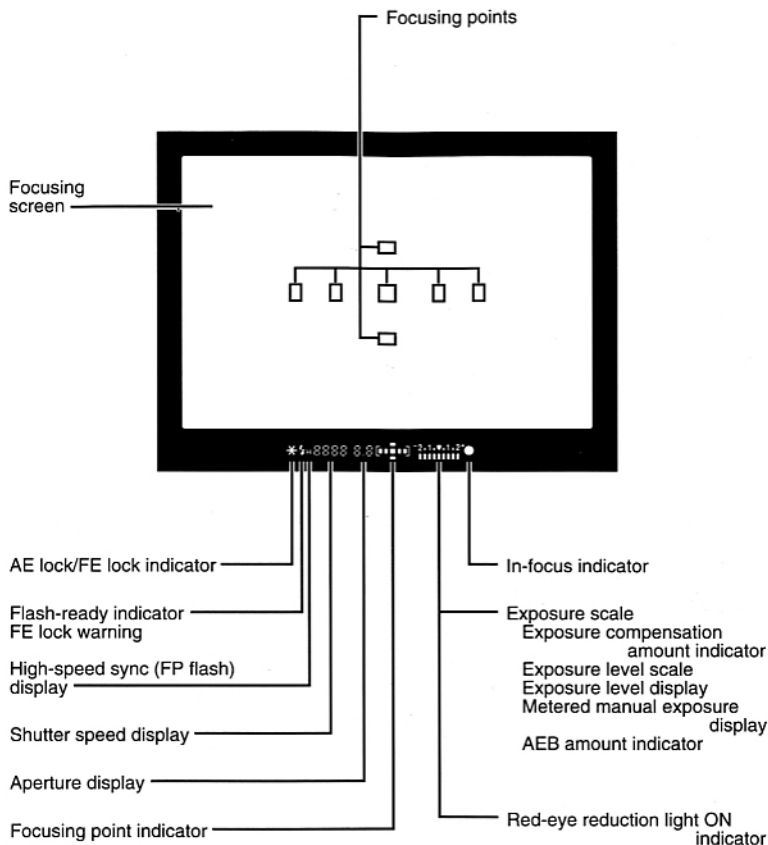

The viewfinder is shown with all the information displayed. The actual information displayed will vary depending on the camera settings and shooting conditions.

## Command Dial

The Command Dial's settings are divided into four zones.

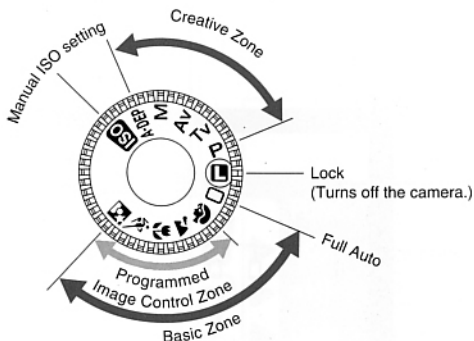

### 1. Basic Zone

 : Full Auto (page 24)

For fully automatic picture-taking.

- All you do is point the camera and press the shutter button.

#### Programmed Image Control Zone

Fully automatic picture-taking to suit the subject type.

- All you do is point the camera and press the shutter button.

 : Portrait (page 28)

 : Landscape (page 29)

 : Close-up (page 30)

 : Sports (page 31)

 : Night Scene (page 32)

### 2. Creative Zone

Control the camera to obtain the desired effect.

**P** : Program AE (page 42)

**Tv** : Shutter speed-priority AE (page 44)

**Av** : Aperture-priority AE (page 46)

**M** : Manual exposure (page 48)

**A-DEP** : Depth-of-field AE (page 50)

### 3. ISO : Manual ISO setting (page 57)

### 4. : Lock



When not using the camera, turn the Command Dial to  (Lock) to prevent accidental operation.

This chapter describes the things you need to know and do before you start using your camera.

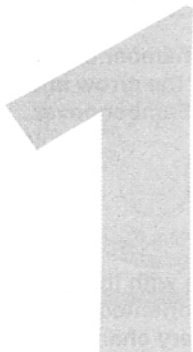

## Before You Start

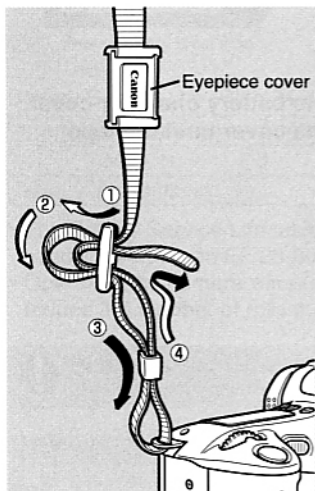

### Attaching the Strap

Pass the end of the strap through the camera's strap eyelet from the bottom. Then pass it through the strap's clasps. Pull the strap to make sure it does not slip out of the clasp.

- The eyepiece cover is also attached to the strap. See page 34.

# Installing the Batteries and Checking the Battery Level

## Installing the Batteries

The camera uses two lithium CR2 batteries.

---

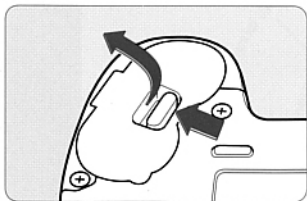

- 1** Slide the battery chamber cover lever as shown by the arrow and open the battery chamber cover.

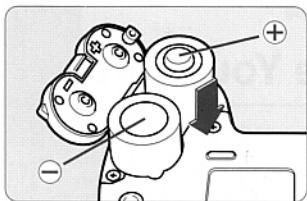

- 2** Insert the batteries with the contacts (+ and -) oriented as shown on the battery chamber cover.
- Do not mix old and new batteries.

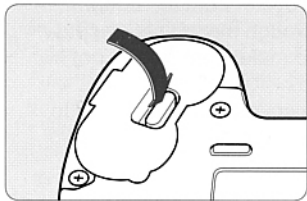

- 3** Close the battery chamber cover. Press the cover until it snaps shut.



## Checking the Battery Level

Check the battery level after replacing the batteries and before using the camera.

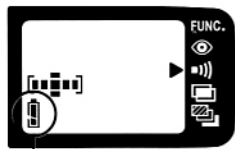
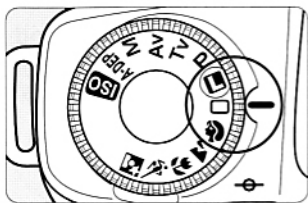

Battery level icon

Turn the Command Dial to any setting except **<BATT>**.

- The camera will then turn on and the LCD panel will display one of the following battery level icons:
  - : Battery level OK.
  - : The battery level is low. Keep spare batteries handy.
  - : Battery exhaustion is imminent.
  - : Replace the batteries. (See page 7.) In this case, the shutter button will not function.

### Battery Service Life (With 24-ex. rolls)

Ambient Temperature	0% Flash Use	50% Flash Use	100% Flash Use
At 20 °C	60	24	12
At -10 °C	40	16	8

- The Battery Service Life table above is based on Canon's testing conditions using an EF 28-80mm f/3.5-5.6 II lens and new batteries.
- Operating the camera without film will still consume battery power. It will reduce the number of rolls that can be taken with the batteries.



If nothing is displayed on the LCD panel, the batteries may have been installed incorrectly. Take out the batteries and install correctly (See page 16).



For places where CR2 batteries may not be easily available, take spare batteries with you. Also carry spare batteries for extended shooting sessions.

# Mounting and Detaching a Lens

## Mounting a Lens

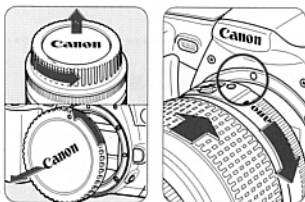

**1** Remove the rear lens cap and the camera body cap.

**2** Align the red dots on the lens and camera and turn the lens as shown by the arrow until it snaps in place.

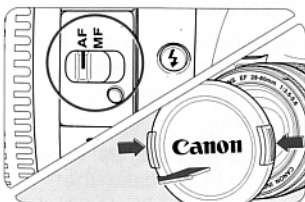

**3** On the lens, set the focus mode switch to AF.

- If the focus mode switch is set to **MF** (or **M** on older lenses), autofocus will not operate.
- While the lens autofocuses, do not touch the lens where it rotates.

**4** Remove the front lens cap.  
• Be careful not to lose the front and rear lens caps.

## Detaching the Lens

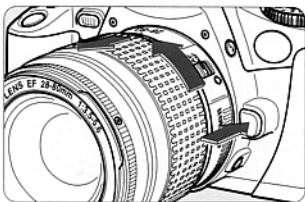

While pressing the lens release button, turn the lens as shown by the arrow until it stops. Then remove the lens.



- **AF** stands for Autofocus.
- **MF** stands for Manual Focus.

# How the Shutter Button Works

The EOS camera's shutter button can be depressed halfway or all the way. There is a click stop at the halfway point.

## Pressing the Shutter Button Halfway or Completely

The shutter button works as described below.

---



### When it is pressed halfway:

- Autofocusing is activated, and when focus is achieved, the beeper sounds and the viewfinder's in-focus indicator lights in green.
- The shutter speed and aperture are also set and displayed on the LCD panel and in the viewfinder.

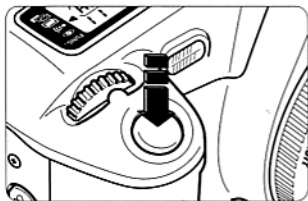

### When it is pressed completely:

- The shutter is released to take the picture and the film advances by one frame.



Camera movement during the moment of exposure is called camera shake. Camera shake can cause blurred pictures.

To prevent blurred pictures due to camera shake:

- Hold the camera steady (see page 22).
- Use the center of your finger to touch the shutter button, grasp the camera with your entire right hand, then press the shutter button gently.

# Loading and Unloading Film

## Loading Film

After you load the film, the camera first winds the entire roll onto the camera's take-up spool. Then each time a picture is taken, one frame of film is rewound back into the film cartridge.

---

**1** Turn the Command Dial to any setting except **<M>**.

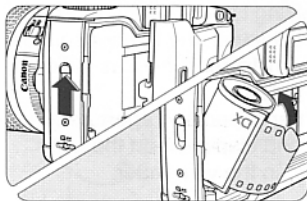

**2** Slide up the camera back lock-release lever to open the camera back.

**3** Insert the film cartridge at an angle as shown in the figure.

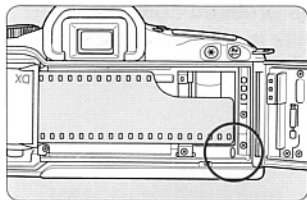

**4** Hold down the film cartridge and pull the edge of the film leader to the orange mark on the camera. Then close the camera back.

- Press down the film cartridge so that it is set securely and the film does not slacken.
- If the edge of the film leader goes beyond the orange mark, push some of the film back into the cartridge.
- While the film is rewinding around the take-up spool, the ISO film speed will be displayed on the LCD panel.
- While the film is rewinding around the take-up spool, the frame counter counts up. When it stops, camera will make a shutter-release sound and the **<M>** icon and total frame count will be displayed.
- If the frame count is not displayed and the **<M>** icon is blinking, it means that the film was not properly loaded. Take out the film cartridge and load it in the camera again.

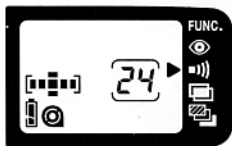



- With DX-coded film, the camera automatically sets the film's ISO speed.
- If the film is not DX-coded, set the ISO speed manually. See page 57.



- Infrared film cannot be used with this camera.
- The shutter curtains are manufactured with very high precision. To prevent damage, never touch the shutter curtains. When loading or unloading film, be careful not to touch the shutter curtain with your fingers or the film.

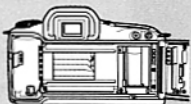

## Unloading Film

After the film's last frame is exposed, the camera rewinds the film automatically.



When the film rewind ends, the camera will make a shutter-release sound and the  icon will blink on the LCD panel. Before opening the camera back to unload the exposed film, make sure the icon is blinking.



## Midroll Film Rewind

To rewind the film before reaching the last frame, follow the steps below.

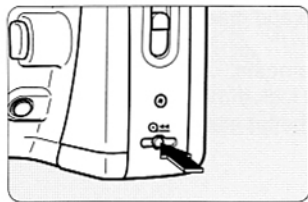

# 1

**Press the  button.**

- The film will start rewinding. The operation will then be the same as normal film rewind.

# 2

**Open the camera back and remove the film.**



If you remove the film from the camera in midroll without rewinding and then load a new roll of film, the new roll's film leader will only be wound back into the film cartridge. To prevent this, close the camera back and press the shutter button completely before loading a new roll of film.

## Holding the Camera

To avoid taking a blurred shot, hold the camera properly as described below.

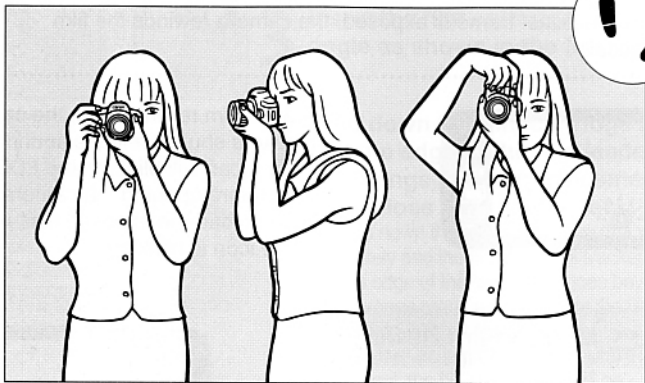

For horizontal shooting.

For vertical shooting.

- Wrap your right hand around the camera grip and grasp firmly. Set your elbow lightly against your body.
- Use your left hand to hold the lens from underneath.
- Press the camera against your forehead and look through the viewfinder.
- Keep one foot slightly ahead of the other for better stability.

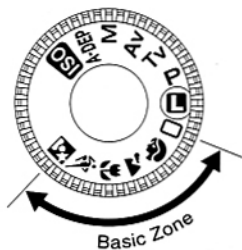

For quick and easy picture-taking, this section describes the Command Dial's Basic Zone modes:  $\langle \square \rangle$ ,  $\langle \text{shutter} \rangle$ ,  $\langle \text{aperture} \rangle$ ,  $\langle \text{flower} \rangle$ ,  $\langle \text{leaf} \rangle$ , and  $\langle \text{box} \rangle$ . These modes set all the camera settings automatically. All you do is point the camera and press the shutter button.

Also, these modes override the camera's Main Dial  $\langle \text{sun} \rangle$  and buttons (except for  $\langle \text{eye} \rangle$ ,  $\langle \text{speaker} \rangle$ ,  $\langle \text{flower} \rangle$ ,  $\langle \text{box} \rangle$ , and the shutter button). This is to prevent spoiled shots caused by accidental operation of camera controls.

## Camera-Controlled Automatic Shooting

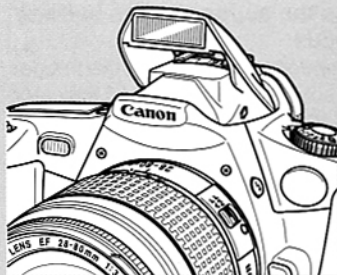



- In the  $\langle \square \rangle$ ,  $\langle \text{shutter} \rangle$ ,  $\langle \text{flower} \rangle$ , and  $\langle \text{box} \rangle$  modes, the built-in flash pops up and fires automatically under low-light or backlit conditions.
- The settings automatically set by the Basic Zone modes are shown in the "Feature Availability Table" on page 64.

## Full Auto Mode

In the  mode, all you do is point the camera and press the shutter button. Photograph any type of subject automatically. Any of the seven focusing points can focus the subject for easy picture-taking.

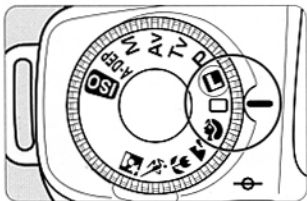
---



**1** Turn the Command Dial to .



Focusing points

**2** Aim any of the focusing points on the subject.

- One of the focusing points will focus the subject as recognized by the camera.
- To focus a subject not covered by any of the focusing points, see page 39.

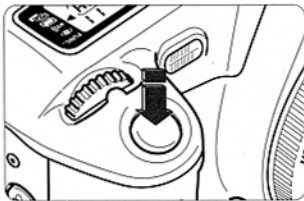

**3** Press the shutter button halfway to focus.

- When focus is achieved, the beeper will sound and the in-focus indicator (●) at the viewfinder's lower right will light.
- The focusing point which achieved focus will light.





- 4 Check the exposure settings.**
- The shutter speed and aperture will be set automatically and displayed in the viewfinder and on the LCD panel.

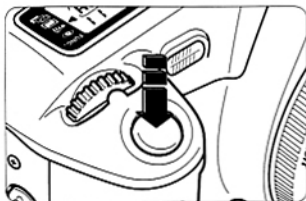

- 5 Compose the shot and press the shutter button completely to take the picture.**



- When focus is achieved, AF lock also takes effect at the same time. See page 39.
- If the in-focus indicator blinks, the shutter cannot be released. See pages 40 and 66.
- Out of the seven focusing points, generally the one covering the closest subject is selected automatically to achieve focus.
- Multiple focusing points may light simultaneously. This means that these focusing points have all achieved focus.



- Under low-light or backlit conditions, the built-in flash will pop up and fire automatically. See page 60 for notes on using the built-in flash.

## Automatic Firing of the Built-in Flash

In the <□>, <📷>, <🌸>, and <📷> modes, the built-in flash pops up and fires automatically under low-light or backlit conditions.



If the automatic pop-up of the built-in flash is obstructed accidentally, the <📷> icon will blink on the LCD panel as a warning. If this happens, press the shutter button halfway. The camera will then return to normal.



If using flash is prohibited or if you want to use existing light instead of flash, use the <P> mode (see page 42).

## AF-Assist with the Built-in Flash

In the Basic Zone modes and Creative Zone modes, the AF-assist lamp lights automatically when necessary.

Under low-light conditions, the built-in flash flashes continuously when you press the shutter button halfway. This is to illuminate the subject to enable easier autofocusing.



- AF-assist does not function in the <📷> and <📷> modes.
- The AF-assist light is effective up to about 4 meters / 13.2 feet.
- In a Creative Zone mode, press the flash button to pop up the flash. The AF-assist light will then turn on when necessary.
- Even while an external EOS-dedicated Speedlite is attached to the camera, the camera's built-in AF-assist light will still function.
- The AF-assist light works in Basic Zone and Creative Zone modes.

## Single-frame and Continuous Shooting

The film advance mode (single or continuous) when the shutter button is held down is set automatically by the respective picture-taking mode.

To see which film advance mode is set by the picture-taking modes, see the "Feature Availability Table" on page 64.

## 👁 Using Red-eye Reduction

When flash is used in a low-light environment, the subject's eyes may look red in the photograph. "Red eye" happens when the light from the flash reflects off the pupils of the eyes.

The camera's red-eye reduction feature uses a red-eye reduction lamp to shine a gentle light into the subject's eyes to narrow the pupil diameter or iris. A smaller pupil reduces the chances of red eye from occurring. Red-eye reduction can be set in any picture-taking mode.

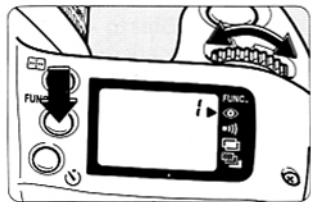

**1** Press the Function button so that the <▶> arrow points to the <👁> icon.

**2** Turn the Main Dial to display "1" on the LCD panel.

- To cancel red-eye reduction, turn the Main Dial to display "0" on the LCD panel.
- The setting takes effect after any of the following actions:
  - The shutter button is pressed halfway.
  - The Command Dial is turned.
  - Six seconds elapse.



Red-eye reduction lamp ON indicator



- When you press the shutter button halfway, the red-eye reduction lamp ON indicator will be displayed in the viewfinder and on the LCD panel to indicate that the red-eye reduction lamp is on.
- For maximum effectiveness, take the picture after the red-eye reduction lamp ON indicator turns off after 1.5 sec.
- You can take a picture even while the red-eye reduction lamp is lit.
- The red-eye reduction lamp also works when an EOS-dedicated Speedlite is attached to the camera.
- The effectiveness of red-eye reduction varies depending on the subject.



- Red-eye reduction can be effective only when the subject looks at the red-eye reduction lamp. Encourage the subject to look at the lamp.
- To increase the effectiveness of red-eye reduction, make the room brighter or move closer to the subject.

## Portrait Mode

THE IMAGE WAS REMOVED DUE  
TO COPYRIGHT RESTRICTIONS

This mode blurs the background to make the human subject stand out.

- Holding down the shutter button executes continuous shooting.

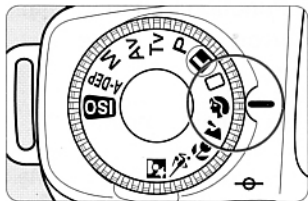

Turn the **Command Dial** to .

- The picture-taking procedure is the same as with the Full Auto mode  (page 24).



- Background blur is most effective when the subject fills the frame from the waist up. Also, the further away the subject is from the background, the more blurred the background will become.
- Using a telephoto lens also increases background blur. If you have a zoom lens, use the longest focal length. (For example, a 28-80mm zoom lens set to 80 mm.)
- Under low-light or backlit conditions, the built-in flash will pop up and fire automatically.
- See page 60 for notes on using the built-in flash.

## Landscape Mode

THE IMAGE WAS REMOVED DUE  
TO COPYRIGHT RESTRICTIONS

This is for sweeping scenery,  
night scenes, etc.

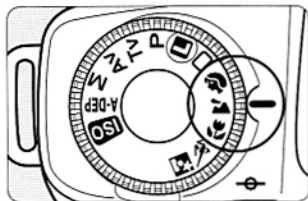

Turn the Command Dial to .

- The picture-taking procedure is the same as with the Full Auto mode  (page 24).



- If the shutter speed display blinks, the shutter speed may be too slow and a blurred picture may occur due to camera shake. Using a tripod is recommended. (The shutter speed will still blink even while a tripod is used.)
- Even if the built-in flash has been popped up, it will not fire.



Using a wide-angle lens will further enhance the depth and breadth of the picture. If you have a zoom lens, use the shortest focal length. (For example, a 28-80mm zoom lens set to 28 mm.)

## Close-up Mode

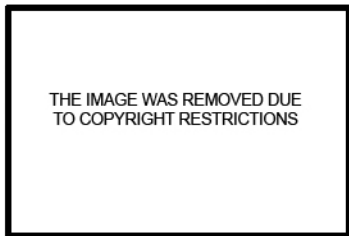

Use this mode to take close-up shots of flowers, insects, etc.

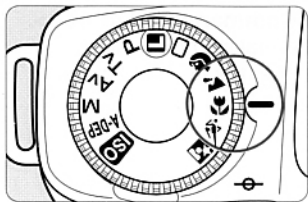

**Turn the Command Dial to <img alt="Flower icon" data-bbox="835 342 865 362"/>.**

- The picture-taking procedure is the same as with the Full Auto mode <img alt="Auto mode icon" data-bbox="515 410 545 430"/> (page 24).



- Focus the subject at the lens' closest focusing distance.
- If you have a zoom lens, use the maximum focal length to obtain a larger magnification.
- For better close-ups, a macro lens and Macro Ring Lite ML-3 (both sold separately) are recommended.
- Under low-light or backlit conditions, the built-in flash will pop up and fire automatically.
- See page 60 for notes on using the built-in flash.

## Sports Mode

THE IMAGE WAS REMOVED DUE  
TO COPYRIGHT RESTRICTIONS

This mode is ideal for sports and fast-moving subjects when you want to freeze the action on film.

- Holding down the shutter button executes continuous focusing and shooting.

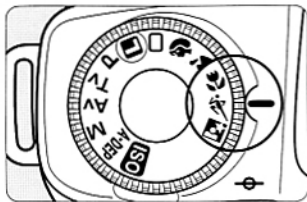

**Turn the Command Dial to <img alt="Sports Mode icon" data-bbox="815 348 845 368"/>.**

- The picture-taking procedure is the same as with the Full Auto mode <img alt="Full Auto mode icon" data-bbox="505 415 535 435"/> (page 24).



- If the shutter speed display blinks, the shutter speed may be too slow and a blurred picture may occur due to camera shake. Using a tripod is recommended. (The shutter speed will still blink even while a tripod is used.)
- Even if the built-in flash has been popped up, it will not fire.



- Using ISO 400 or faster film is recommended.
- For sports photography, a telephoto lens with a focal length of 200 mm or 300 mm is recommended.



## Night Scene Mode

THE IMAGE WAS REMOVED DUE  
TO COPYRIGHT RESTRICTIONS

This mode is for taking pictures of people at dusk or at night. The flash illuminates the subject properly while a slow shutter speed exposes the background to attain a natural-looking, balanced exposure. To prevent camera shake, using a tripod is recommended.

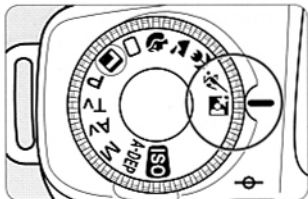

Turn the Command Dial to **< [Night Scene Mode Icon] >**.

- The picture-taking procedure is the same as with the Full Auto mode **< [Full Auto Mode Icon] >** (page 24).



- Using ISO 400 or faster film is recommended.
- If only a night scene (without people) is to be photographed, use the **< [Night Scene Mode Icon] >** mode instead.
- Tell the subject to keep still even after the flash fires.
- If the self-timer is also used in this mode, the red-eye reduction lamp will flash for a moment to indicate that the exposure has been completed.
- The **< [Night Scene Mode Icon] >** mode can be used even while an EOS-dedicated Speedlite is attached to the camera.
- In daylight, the **< [Night Scene Mode Icon] >** mode functions in the same way as the **< [Full Auto Mode Icon] >** mode.





## Self-timer

The self-timer is useful when you want to be in the picture. It can be used in Basic Zone and Creative Zone modes. Use a tripod for self-timer shots.

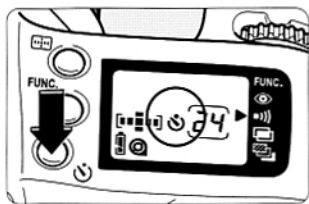
---



### 1 Press the self-timer button .

- The  icon will be displayed on the LCD panel.
- To cancel the self-timer, press the self-timer button  again or turn the Command Dial to .

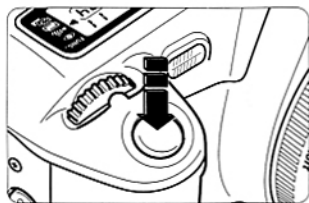

### 2 Look through the viewfinder and press the shutter button completely to start the self-timer.

- The picture-taking procedure is the same as with the Full Auto mode  (page 24).
- When you press the shutter button completely, the beeper will sound and the shutter will be released 10 sec. later.  
During the first 8 seconds, the beeper beeps slowly and the red-eye reduction lamp flashes.  
During the final 2 seconds, the beeper beeps faster and the red-eye reduction lamp stays lit.
- On the LCD panel, the self-timer display counts down in seconds.



- The self-timer beeper can be silenced. See page 54.
- The self-timer will be canceled automatically if you do not press the shutter button within 4 minutes after pressing the self-timer button.



- To cancel the self-timer after it starts, press the self-timer button <Self-timer icon> again.
- When using the self-timer to take a picture of only yourself, first lock the focus (see page 39) on an object at the same distance where you will be in the picture.
- With Remote Switch RS-60E3 (sold separately), you can press the shutter button at a remote distance. See page 58.



Do not stand in front of the camera when you start the self-timer. Doing so will throw off the focus.

## Using the Eyepiece Cover

If you use the self-timer and take a picture without looking through the viewfinder, stray light may enter the eyepiece and affect the exposure. To prevent this, attach the eyepiece cover on the eyepiece before taking the picture.

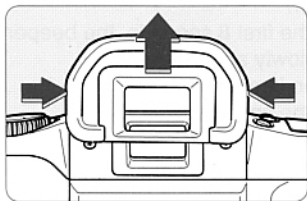

**1** Remove the eyecup from the eyepiece.

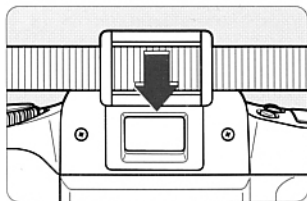

**2** Slip the eyepiece cover (attached to the strap) onto the eyepiece.

## Imprinting the Date or Time (QD Model only) ■

THE IMAGE WAS REMOVED DUE  
TO COPYRIGHT RESTRICTIONS

The QD version of the camera has a quartz date feature which maintains an automatic calendar up to the year 2019. It can imprint the date or time on the photograph as shown in the left photo. The imprinting can also be disabled so nothing is imprinted. The date or time can be imprinted in any picture-taking mode.

The date or time is imprinted on the lower right corner of the picture as shown above.

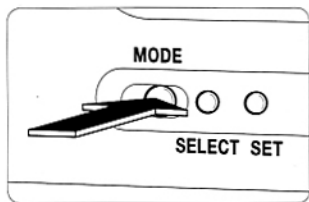

**To change the date/time imprinting format, press the <MODE> button.**

- Each time the button is pressed, the imprinting format changes in the following sequence as shown on the quartz date display panel:

Day, month, year	24 <sup>M</sup> 12 99	(24 Dec. 1999)
↓		
Year, month, day	99 <sup>M</sup> 12 24	(1999 Dec. 24)
↓		
Day, hour, minute	24 16:45	(24th 16:45)
↓		
Hyphens	- - - -	(Blank)
↓		
Month, day, year	12 24 99 <sup>M</sup>	(Dec. 24, 1999)

- "M" is displayed above the month.
- The bar above the last two digits is the imprint indicator. It blinks to indicate that the date or time is being imprinted when the picture is taken.

## Setting the Date and Time

To set or change the date and time, follow the procedure below.

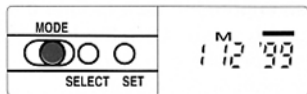

- 1** Press the <MODE> button to display the date or time to be set.

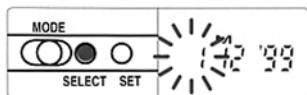

- 2** Press the <SELECT> button so that the digit to be changed blinks.

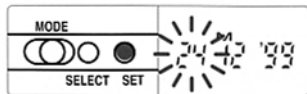

- 3** Keep pressing the <SET> button until the correct number appears.

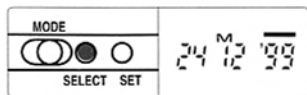

- 4** Press the <SELECT> button until none of the digits blink.

## Replacing the Quartz Date Back's Battery

When the date/time on the quartz date display panel or imprinted photograph looks faded, replace the CR2025 lithium battery as follows. Battery life is about 3 years.

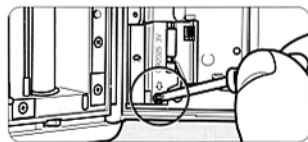

- 1** Open the camera back and loosen the screw to remove the battery chamber cover as shown in the figure.

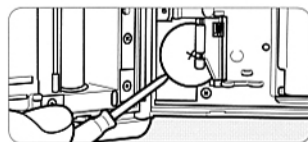

- 2** Take out the battery.
- 3** Insert a new battery with the positive contact (+) facing you. Then reattach the battery chamber cover.
- 4** Close the camera back and set the correct date and time.

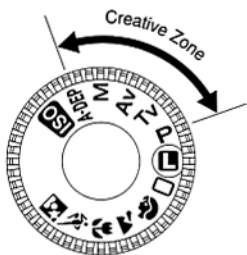

The Creative Zone modes enable you to control the camera to obtain the effect you want. Shutter speed-priority, aperture-priority, and other user-controllable modes are provided. The Creative Zone modes (**P**, **Tv**, **Av**, **M**, and **A-DEP**) are described here along with other advanced operations.

# 3

## User-Controlled Shooting

- The  icon indicates the Main Dial.
- Even after the shutter button is pressed and released, the shutter speed and aperture will remain displayed on the LCD panel and in the viewfinder for about 4 seconds.
- Depth-of-field preview, AE lock, exposure compensation, autoexposure bracketing, bulb exposures, and multiple exposures can be used only in Creative Zone modes.
- The settings automatically set by the Creative Zone modes are shown in the “Feature Availability Table” on page 64.

# Focusing Point Selection

The focusing point is shown as a little box. The focusing point can be selected automatically or manually. In the Full Auto, Programmed Image Control modes, and <A-DEP> mode, the focusing point is selected automatically. In the <P>, <Tv>, <Av>, and <M> modes, the focusing point can be selected automatically or manually.

**Automatic selection:** The camera selects the focusing point automatically. Suited for snapshots.

**Manual selection:** You can select any one of the seven focusing points to achieve focus. It is convenient when you want to make sure the target subject is focused or when you want to retain the off-center framing of the subject.

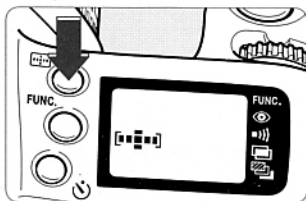

## 1 Press the <Fn> button.

- The selected focusing point will be displayed.
- The focusing point will be displayed and effective for about 6 sec. after the button is released.

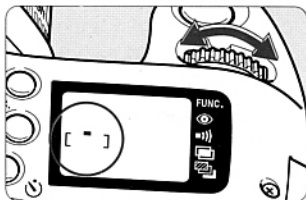

## 2 Turn the <Fn> dial to select the desired focusing point. When the dial is turned, the focusing point selection shifts in the loop shown below:

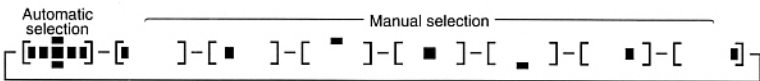

**3 Press the shutter button halfway.**

- The camera will return to normal.
- Even if the shutter button is not pressed halfway, the focusing point selection mode will terminate after about 6 sec.



If the focusing point has been selected manually and the Command Dial is turned to Full Auto or a Programmed Image Control mode, the focusing point selection will switch to automatic.

## Focusing Subjects not Covered by the Focusing Points

If you want to focus a subject not covered by any of the focusing points, use AF lock as described below.



**1** Select the desired focusing point.  
(See page 38.)

**2** Aim the focusing point on the subject, then press the shutter button halfway to focus.



**3** Keep pressing the shutter button halfway and recompose the picture as desired.

**4** Press the shutter button completely to take the picture.



AF lock can also be used in the Basic Zone modes.

## When Autofocus Fails (Switching to Manual Focus)

The camera has a high-precision AF system which can focus almost all subjects. However, it can fail to achieve focus (the in-focus indicator blinks) with the subjects listed below.

### Difficult Subjects for Autofocusing

- (a) Low-contrast subjects.  
Example: Blue sky, solid colors on a flat surface, etc.
- (b) Extremely backlit or reflective subjects.  
Example: Automobile with a highly reflective finish.
- (c) Overlapping near and far objects.  
Example: Animal behind bars in a cage.

In such cases, focus an object at the same distance as the subject and lock the focus before recomposing. (See page 39) Or focus manually by following the procedure below.

### Manual Focusing

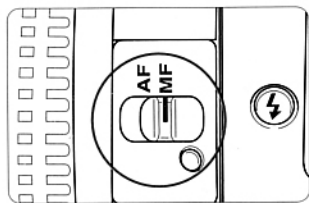

- 1 Set the lens focus mode switch to MF (or M on older lenses).

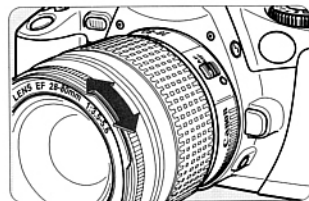

- 2 Turn the lens focusing ring until the subject is in focus in the viewfinder.



The focusing point(s) which achieves focus lights in the viewfinder, and the in-focus indicator (●) also lights.



# Metering Modes

The camera has three metering modes: Evaluative, partial, and centerweighted averaging metering. Evaluative metering is the standard metering mode. Partial metering is set automatically when AE lock is used (see page 51), and centerweighted averaging metering is set automatically in the <M> mode (see page 48).

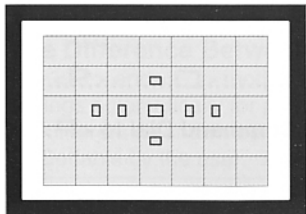

## Evaluative metering

This is suited for most picture-taking situations including backlit conditions. The subject's position and brightness, the background, the existing light, backlight conditions, and the active focusing points are taken into account to obtain a suitable exposure.

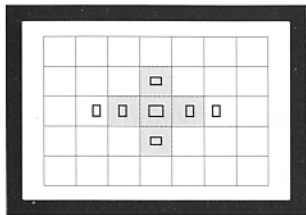

## Partial metering

The exposure setting is based on the brightness of an area 9.5% of the viewfinder screen at the center. It is effective for backlit subjects.

- The partial metering area (shaded) is approximated by the diagram on the left.

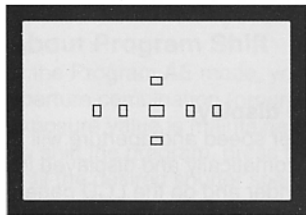

## Centerweighted averaging metering

The metering is weighted at the center and then averaged for the entire scene.



In the One-Shot AF and AI Focus AF modes (except AI Servo AF) (see page 64), AE lock takes effect automatically when you press the shutter button halfway to focus.

- You cannot set or change the metering mode manually.

# P Program AE

THE IMAGE WAS REMOVED DUE TO COPYRIGHT RESTRICTIONS

Like the <□> mode, this is a general-purpose picture-taking mode for snapshots. The camera automatically sets the shutter speed and aperture to suit the subject's brightness.

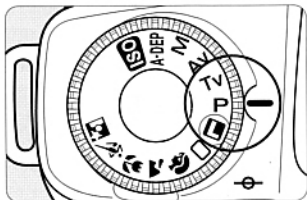

**1** Turn the Command Dial to <P>.

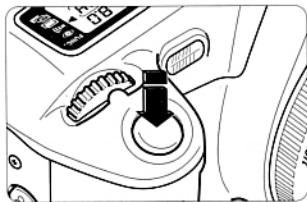

**2** Press the shutter button halfway to focus.

- When focus is achieved, the beeper will sound and the in-focus indicator (●) at the lower right will light.

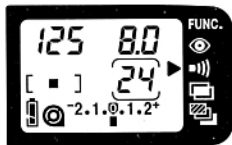

**3** Check the display.

- The shutter speed and aperture will be set automatically and displayed in the viewfinder and on the LCD panel.
- If the shutter speed and aperture do not blink, a correct exposure will be obtained.
- If the shutter speed and aperture blink, see "Exposure Warnings" on page 65.

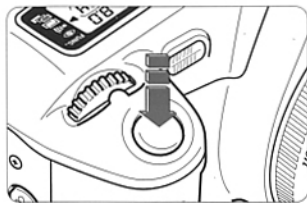

**4** Compose the shot and press the shutter button completely to take the picture.

## The Difference Between P and □

The <P> and <□> modes set the same shutter speed and aperture settings automatically for picture-taking. However, the available features are different as shown below.

○: Settable by the user. ×: Not settable by the user.

Feature	P	□ Full Auto
Continuous shooting	○	×
Program shift	○	×
Exposure compensation	○	×
Auto Exposure bracketing	○	×
Partial metering/AE lock	○	×
Manual focusing point selection	○	×
Built-in flash ON/OFF	○	×
High-speed sync with an EX-series Speedlite	○	×
FE lock with an EX-series Speedlite	○	×

## About Program Shift

In the Program AE mode, you can freely change the shutter speed and aperture combination (program) set by the camera while the same exposure value is maintained. This is called program shift.

To shift the program, press the shutter button halfway and turn the <☀> until the desired shutter speed or aperture is displayed.

- After the picture is taken with the shifted program, the shifted program is canceled automatically and the original program is restored.
- If the built-in flash is used, the program cannot be shifted.



"AE" stands for autoexposure.

# Tv Shutter-Speed Priority AE

In this mode, you set the shutter speed and the camera sets the aperture automatically to suit the brightness of the scene.

A fast shutter speed can freeze the motion of a fast-moving subject. Or, a slow shutter speed can blur the subject to give the impression of motion.

Set the desired shutter speed with the <  >.

\* **Tv** stands for Time value which is the shutter speed.

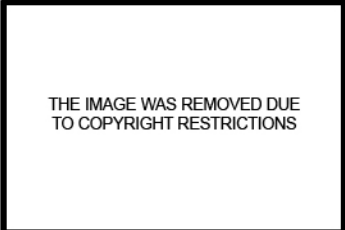

THE IMAGE WAS REMOVED DUE  
TO COPYRIGHT RESTRICTIONS

Taken with a fast shutter speed.

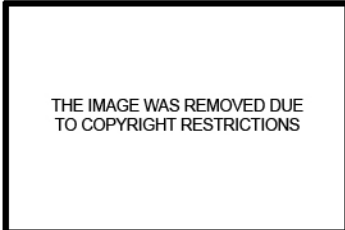

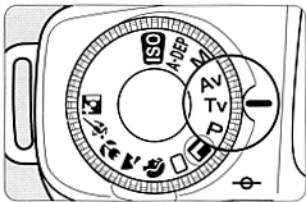

THE IMAGE WAS REMOVED DUE  
TO COPYRIGHT RESTRICTIONS

Taken with a slow shutter speed.

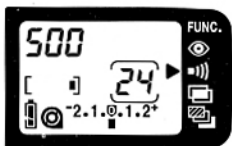

**1** Turn the Command Dial to < **Tv** >.



**2** Select the desired shutter speed with the <  >.

- Turn the <  > until the desired shutter speed is displayed.

**3** Press the shutter button halfway to focus the subject.

500 4.0C [ ]<sup>-2,1,1,1,2\*</sup>

## 4 Check the viewfinder display.

## 5 Press the shutter button completely to take the picture.

500 -3.5E [ ]<sup>-2,1,1,1,2\*</sup>

• If the maximum aperture (the smallest f-number) blinks, the scene is too dark. In such a case, turn the <  > to set a slower shutter speed until the aperture display stops blinking.

60 -2.2E [ ]<sup>-2,1,1,1,2\*</sup>

• If the minimum aperture (the largest f-number) blinks, the scene is too bright. In such a case, turn the <  > to set a faster shutter speed until the aperture display stops blinking.



To photograph a scene on a TV screen, use a shutter speed of 1/15 sec. for best results. Use a tripod to prevent blur.

**Shutter Speed Display**

The shutter speed can be set and displayed in full and half stops. Shutter speeds from 2 to 2000 indicate the denominator of the fractional shutter speed. For example, 125 is 1/125 second. For slower shutter speeds, the numeral is appended with the seconds mark ("). For example, 0"7 is 0.7 second and 15" is 15 seconds.

2000 1500 1000 750 500 350 250 180 125 90 60 45 30 20  
15 10 8 6 4 3 2 0"7 1" 1"5 2" 3" 4" 6" 8" 10" 15" 20" 30"

# Av Aperture-Priority AE/Depth-of-field Preview

In this mode, you set the aperture and the camera sets the shutter speed automatically to suit the brightness of the scene.

A large aperture (small f-number) can blur the background and make the subject stand out.

Or, a small aperture (large f-number) can increase the depth of field to make both the foreground and background look sharp.

Set the desired aperture with the <  >.

\* **Av** stands for aperture value.

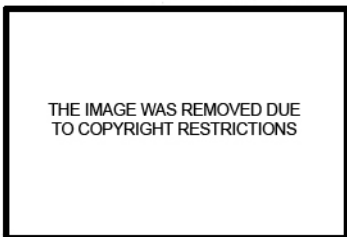

Taken with a large aperture (such as f/3.5)

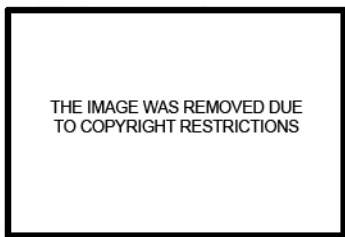

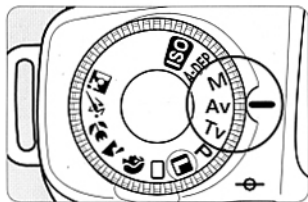

Taken with a small aperture (such as f/22)

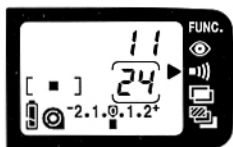

**1** Turn the Command Dial to <Av>.



**2** Select the desired aperture with the <  >.

- Turn the <  > until the desired aperture is displayed.

**3** Press the shutter button halfway to focus the subject.

60 1:1 [ ]<sup>-2,1,1,2\*</sup>

4 Check the viewfinder display.

5 Press the shutter button completely to take the picture.



- If the 30" shutter speed blinks, the scene is too dark. In such a case, turn the <  > to set a larger aperture (smaller f-number) until the shutter speed display stops blinking.



- If the 2000 shutter speed blinks, the scene is too bright. In such a case, turn the <  > to set a smaller aperture (a larger f-number) until the shutter speed display stops blinking.



### Aperture Display

The aperture can be set and displayed in full and half stops as shown below. The larger the number, the smaller the aperture opening will be. The displayable range of apertures depends on the lens mounted on the camera.

1.0 1.2 1.4 1.8 2.0 2.5 2.8 3.5 4.0 4.5 5.6 6.7 8.0 9.5 11 13  
16 19 22 27 32 38 45 54 64 76 91

If no lens is mounted on the camera, "00" will be displayed for the aperture setting.

## Depth-of-field Preview

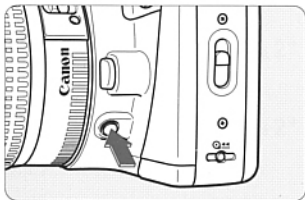

To check the depth of field visually, press the depth-of-field preview button. The camera will stop down the aperture and you can check the depth of field in the viewfinder.



- Depth-of-field preview can be used only in Creative Zone modes.
- The < **A-DEP** > mode takes effect after you press the shutter button halfway.
- When you press the depth-of-field preview button, AE lock also takes effect.

# M Manual Exposure

THE IMAGE WAS REMOVED DUE  
TO COPYRIGHT RESTRICTIONS

In this mode, you set the shutter speed and the aperture for total exposure control. The exposure level of the shutter speed and aperture you set is indicated on the exposure level scale. You can check whether the exposure will be suitable or not.

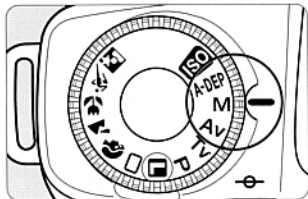

**1** Turn the Command Dial to **<M>**.



**2** Select the desired shutter speed with the **<  >**.

- Turn the **<  >** until the desired shutter speed is displayed.



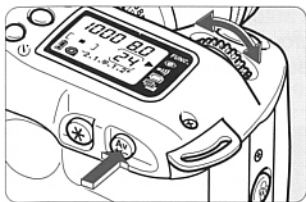

**3** Select the desired aperture by holding down the  $\langle \text{Av} \rangle$  button and turning the  $\langle \text{Aperture} \rangle$ .

- Turn the  $\langle \text{Aperture} \rangle$  until the desired aperture is displayed.

**4** Press the shutter button halfway to focus the subject.

**5** Check the viewfinder display.



**6** Look at the exposure level indicator and adjust the exposure level with the  $\langle \text{Exposure} \rangle$  if necessary.

Correct exposure: This is the standard level for a correct exposure.

Overexposure: To achieve the correct exposure, set a faster shutter speed or a smaller aperture.

Underexposure: To achieve the correct exposure, set a slower shutter speed or a larger aperture.

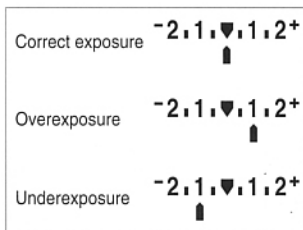

**7** Press the shutter button completely to take the picture.

## A-DEP Automatic Depth-of-Field AE

This mode is for obtaining a wide depth of field automatically between a near subject and far subject. It is effective for group photos and landscapes. The camera uses the 7 focusing points to detect the nearest and farthest subjects to be in focus.

\* <A-DEP> stands for Auto Depth-of-field.

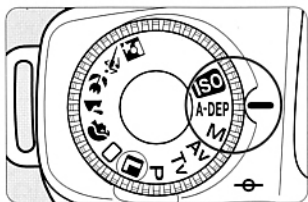

**1** Turn the Command Dial to <A-DEP>.



**2** Aim the focusing points over the subjects and press the shutter button halfway to focus.

- The focusing points which achieve focus will light on the display. Sharp focus will be attained for the nearest and farthest subjects covered by the focusing points.
- While the exposure settings are displayed in the viewfinder, you can check the depth of field (see page 47).



**3** Check the viewfinder information and take the picture.

- In the sample photo, the focus will be sharp from the left boy in the distance to the right boy in the foreground.



- If the aperture blinks, it indicates that the exposure level is correct but the desired depth of field cannot be achieved. Either use a wide-angle lens or move further away from the subjects.
- In this picture-taking mode, you cannot freely change the shutter speed and aperture. If the camera sets a slow shutter speed, hold the camera steady or use a tripod.
- If flash is used, the result will be the same as using flash in the <P> mode.
- The <A-DEP> mode cannot be used if the lens' focus mode switch is set to MF (or M on older lenses).

## \* Partial Metering Using AE Lock

In high-contrast situations such as a person spotlighted against a dark background, the exposure may turn out too bright or too dark in certain areas of the photograph. To obtain a more accurate exposure in such cases, use AE lock to lock the subject's exposure level.



**1** Aim the center of the viewfinder over the area where you want to lock the exposure. Then press the shutter button halfway to focus.

**2** Press the < \* > button.

- The < \* > indicator lights in the viewfinder and the exposure level locks (AE lock). The indicator remains displayed 4 sec. after you let go of the < \* > button.
- Each time you press the < \* > button, AE lock takes effect for the current exposure level.
- AE lock is canceled 4 sec. after you let go of the < \* > button or if you turn the Command Dial.
- If the Command Dial is set to < M > (see page 48), the exposure level index will show the difference between the exposure level you have set manually and the subject's brightness based on partial metering.
- If AE lock is to be executed again, keep pressing the < \* > button and press the shutter button.

**3** Compose the shot and take the picture.

# Exposure Compensation

Changing the exposure level set by the camera is called exposure compensation. Exposure compensation can be used to make the picture darker or brighter intentionally. Exposure compensation can be set up to  $\pm 2$  stops in half-stop increments.

- 1 Turn the Command Dial to a Creative Zone mode except  $\langle M \rangle$ .
- 2 Press the shutter button halfway and check the exposure display.

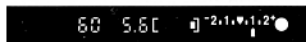
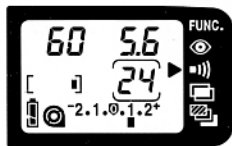
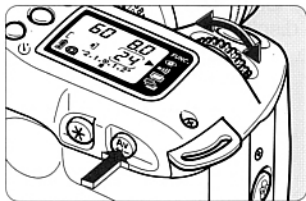
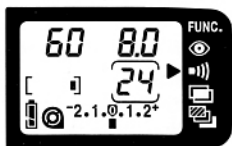

- 3 Press and hold down the  $\langle \text{Av} \rangle$  button and turn the  $\langle \text{Exposure Compensation} \rangle$  until the desired exposure compensation amount is set.
- The plus side of the scale indicates overexposure and the minus side of the scale indicates underexposure.

-2.1.0.1.2+

Underexposure  $\leftarrow \dots \dots \dots \blacksquare \dots \dots \dots \rightarrow$  Overexposure

- To cancel the exposure compensation setting, set the exposure level indicator to  $\text{0}$ . The exposure compensation setting will not be canceled automatically when the Command Dial is set to  $\langle L \rangle$ .

- 4 Take the picture.



- The exposure compensation setting will be canceled if the Command Dial is set to a Basic Zone mode.
- Assuming that a shutter speed of 1/125 sec. and an aperture of f/5.6 will give a correct exposure, setting the exposure compensation amount to plus or minus 1 stop on the exposure level scale will be equivalent to the following settings:

	-1 stop	$\leftarrow$	0	$\rightarrow$	+1 stop
Shutter Speed	250	$\leftarrow$	125	$\rightarrow$	60
Aperture	8.0	$\leftarrow$	5.6	$\rightarrow$	4.0



## Auto Exposure Bracketing (AEB)

With autoexposure bracketing, the camera automatically changes the exposure level within the set range for three successive frames. The bracketing amount centers on the correct exposure and the bracketed exposures can be varied up to  $\pm 2$  stops in 1/2-stop increments. The three bracketed shots are exposed in the following sequence: Correct exposure, underexposure, and overexposure. Auto Exposure bracketing is useful for obtaining subtle lighting effects especially with slide film.

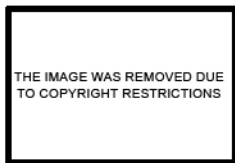

Correct exposure

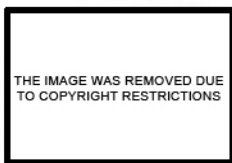

Underexposure (-1.0 stop)

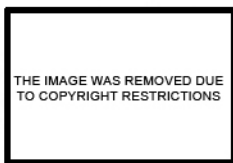

Overexposure (+1.0 stop)

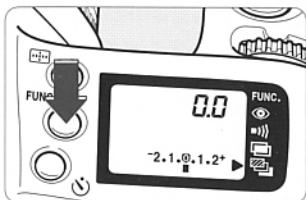

**1** Press the Function button and point the  $\langle \blacktriangleright \rangle$  arrow to  $\langle \text{FUNC.} \rangle$ .

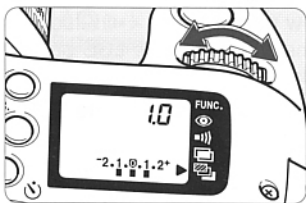

**2** Turn the  $\langle \text{AEB dial} \rangle$  dial to set the desired bracketing amount.

- For example, if 1.0 is set, the underexposed and overexposed frames will be exposed at -1.0 and +1.0 stop respectively.
- To cancel autoexposure bracketing, set the desired bracketing amount to 0.0. The bracketing amount will not be canceled even if you turn the Command Dial to  $\langle \text{L} \rangle$ .
- The setting takes effect after any of the following actions:
  - The shutter button is pressed halfway.
  - The Command Dial is turned.
  - Six seconds elapse.

-2.1.▼.1.2+ : Correct exposure

-2.1.▼.1.2+ : Underexposure

-2.1.▼.1.2+ : Overexposure

### 3 Take the pictures.

- The viewfinder and LCD panel will display the respective exposure level for each bracketed shot.
- During AEB shooting while the exposure level is displayed, the arrow pointing to the AEB icon on the LCD panel will blink along with the exposure level index.



- AEB is not canceled automatically. To cancel AEB, set the bracketing amount to 0.0.
- If the self-timer is used, the three AEB shots will be taken in continuous succession automatically.
- If the Command Dial is set to a Basic Zone mode, AEB will be canceled automatically.
- If flash is used, AEB cannot be executed.



- In the continuous shooting mode, holding down the shutter button will take all three bracketed shots continuously. However, the respective exposure level will not be displayed.
- AEB can be used in combination with exposure compensation. If the bracketing range exceeds the displayable range, the display will be as shown on the right (with a sample AEB amount of  $\pm 1$  stop).

-2.1.▼.1.2+ : AEB amount of  $\pm 1$  stop.

-2.1.▼.1.2+ :  $\pm 1$  stop AEB with -1-stop exposure compensation.

-2.1.▼.1.2+ :  $\pm 1$  stop AEB with -1.5-stop exposure compensation.

-2.1.▼.1.2+ :  $\pm 1$  stop AEB with -2-stop exposure compensation.

## Silencing the Beeper

The beeper can be silenced in all of the picture-taking modes.

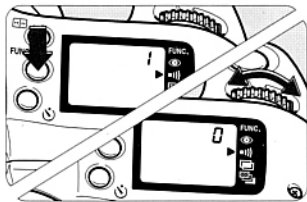

### 1 Press the Function button so that the $\langle \blacktriangle \rangle$ arrow points to the $\langle \text{Beeper} \rangle$ icon.

- The frame counter on the LCD panel will display "1."

### 2 Turn the $\langle \text{Beeper} \rangle$ dial so that the LCD panel displays "0."

- To enable the beeper again, turn the  $\langle \text{Beeper} \rangle$  dial so that "1" is displayed.
- The setting takes effect after any of the following actions:
  - The shutter button is pressed halfway.
  - The Command Dial is turned.
  - Six seconds elapse.

# Bulb Exposures

A bulb exposure starts when you press the shutter button completely and ends when you release the shutter button. Bulb exposures are useful when long exposures are required for night scenes, fireworks, heavenly bodies, etc. Remote Switch RS-60E3 (sold separately) is convenient since it frees you from holding down the shutter button during bulb exposures.

1 Turn the Command Dial to <M>.

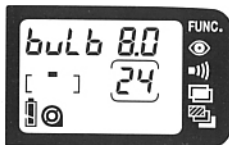

2 Turn the <☀> dial until *bulb* is displayed for the shutter speed.  
• *bulb* follows 30".

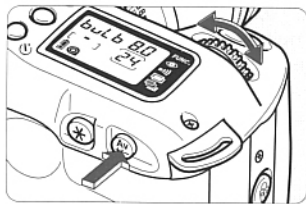

3 Press and hold down the <Av> button and turn the <☀> to set the desired aperture.

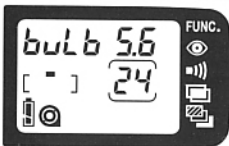

4 Frame the shot, then press and hold down the shutter button completely for the duration of the exposure.

- The shutter remains open while the shutter button is pressed completely.
- During bulb exposures, <*bulb*> blinks on the LCD panel.
- With a new set of batteries, a bulb exposure can be as long as about 4.5 hours at room temperature.
- A bulb exposure can be combined with multiple exposures (see page 56).

## Multiple Exposures

A single frame can be exposed multiple times to obtain a special effect. This is possible in the Creative Zone modes.

---



**1** Press the Function button to point the <▶> arrow to the  icon on the LCD panel.

- "1" will be displayed on the LCD panel.

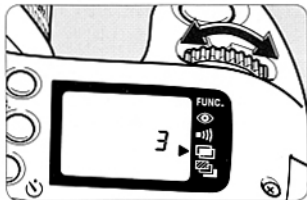

**2** Turn the  dial to set the desired number of multiple exposures.

- The LCD panel will show the number of multiple exposures.
- Up to 9 multiple exposures can be set.
- To cancel the multiple-exposure setting, set the number of multiple exposures to 1.

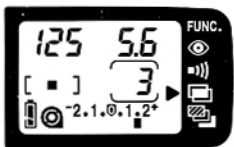

**3** Compose the shot and press the shutter button completely to take the picture.

- After the first exposure, pressing the shutter button halfway will have the <▶> arrow (pointing to ) blink on the LCD panel.
- After the set number of multiple exposures are taken, the film advances to the next frame and the multiple-exposure setting is canceled.
- To cancel the multiple-exposure setting before completing all the multiple exposures, follow steps 1 and 2 to set the number of multiple exposures to blank.
- The setting takes effect after any of the following actions:
  - The shutter button is pressed halfway.
  - The Command Dial is turned.
  - Six seconds elapse.





Before capturing multiple exposures on the same frame of film, exposure compensation must be set. See "Exposure Compensation" on page 52. As a general guide, you should set the exposure compensation amount shown below for the respective number of multiple exposures.

No. of Multiple Exposures	2	3	4
Exposure Compensation Amount	-1.0 stop	-1.5 stop	-2.0 stops

- These are only suggested exposure compensation amounts. The optimum amount depends on the scene. Experiment to find the optimum compensation amount.
- If the Command Dial is turned to a Basic Zone mode, the multiple-exposure setting will be canceled automatically.

## ISO Setting the ISO Film Speed

If the film is not DX-coded or if you want to set a different ISO film speed, you can set the ISO film speed manually. The ISO film speed can be set from 6 to 6400.

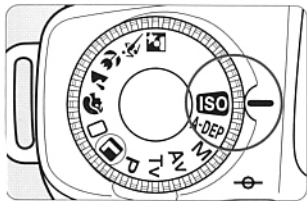

- 1 Turn the Command Dial to **<ISO>**.
  - The ISO icon and the current ISO film speed will be displayed on the LCD panel.



- 2 Turn the **<ISO>** until the desired ISO film speed appears on the LCD panel.
- 3 Turn the Command Dial to the desired mode.



The manually-set ISO film speed will be canceled if the film is taken out and DX-coded film is loaded.

## Using the Remote Switch (Sold separately)

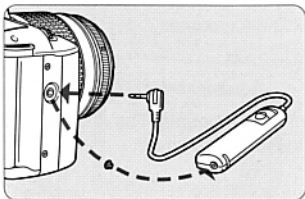

Wireless remote control can be used in all picture-taking modes.

---

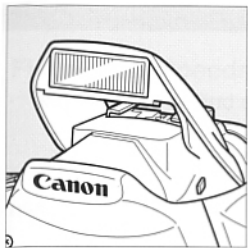

**Connect the Remote Switch RS-60E3's plug to the camera's remote control socket. Press the release button to take the picture.**



- In the Basic Zone modes (except  and ) , the built-in flash will pop up and fire automatically when necessary in low-light or backlit conditions.
- In Creative Zone modes, flash photography is possible at anytime by pressing the  button. You can also set the flash aperture and sync speed (1/90 sec. or slower) and the flash exposure will be controlled automatically to suit the flash aperture you have set.

## Using the Built-in Flash



### Using an External EOS-Dedicated Speedlite

When an external EOS-dedicated, EX-series Speedlite like the 220 EX or 380 EX is attached to the camera, flash photography is as easy as with the built-in flash. E-TTL autoflash linked to the seven focusing points, high-speed sync (FP flash) which enables flash synchronization at all shutter speeds, and flash exposure (FE) lock (similar to AE lock) also become possible. An external Speedlite is effective for large group photos, portrait lighting effects, etc., when a high flash output is required.

The features available with an EX-series Speedlite differ depending on the camera. Since the EOS Rebel 2000/EOS 300 is a Type-A camera, see the section in the Speedlite's Instructions which applies to Type-A cameras.

# Using the Built-in Flash

## In a Basic Zone Mode

In a Basic Zone mode (except <  > and <  >), the built-in flash will pop up and fire automatically in low-light or backlit conditions.

## In a Creative Zone Mode

When using a Creative Zone mode, press the <  > button to use the built-in flash.

- P** : Use this mode for automatic flash photography. The flash sync speed and flash aperture will be set automatically as with the <  > (Full Auto) mode.
- Tv** : Use this mode if you want to use a flash sync speed slower than 1/90 sec. The camera will set the flash aperture automatically to obtain a correct flash exposure.
- Av** : Use this mode if you want to set the flash aperture. With this mode, you can obtain a balanced flash exposure between the subject and background. The camera will set a slow sync speed automatically. The flash illuminates the subject while the background is exposed with a long shutter speed.
- Be sure to use a tripod when a slow sync speed is set.
- M** : This mode enables you to set both the flash sync speed and flash aperture. The subject is properly exposed with the flash and the background is exposed with the flash sync speed and aperture you have set.
- A-DEP** : The result will be the same as using the < **P** > mode.

## Built-in Flash Range (With EF 28-80mm f/3.5-5.6II lens)

ISO	28 mm		80 mm		
	Negative Film	Reversal Film	Negative Film	Reversal Film	
100	m	1 - 4.8	1 - 3.4	1 - 3	1 - 2.1
	ft	3.3 - 15.9	3.3 - 11.2	3.3 - 9.9	3.3 - 7.0
400	m	1 - 9.7	1.2 - 6.8	1 - 6	1 - 4.3
	ft	3.3 - 31.8	3.9 - 22.5	3.3 - 19.9	3.3 - 14.0

## Flash Sync Speeds and Flash Apertures

Mode	Sync Speed	Flash Aperture
<b>P</b>	The sync speed is set automatically to 1/90 sec.	The flash aperture is set automatically according to the TTL program.
<b>Tv</b>	Any sync speed 1/90 sec. or slower can be set manually.*	The flash aperture is set automatically to match the sync speed you set.
<b>Av</b>	The sync speed is set automatically within a range of 30" to 1/90 sec. to match the flash aperture you set and the subject brightness.	You set the flash aperture manually.
<b>M</b>	You set the flash aperture manually.*	

\* If the sync speed is set faster than 1/90 sec., it will be reset automatically to 1/90 sec.



- If you set a sync speed faster than 1/90 sec. in the <Tv> and <M> modes, the sync speed will be set automatically to 1/90 sec.
- An external, EOS-dedicated Speedlite and the built-in flash cannot be used together.
- Before attaching an EOS-dedicated Speedlite to the camera, push down the built-in flash if it is popped up.



- When using the built-in flash, stay at least 1 meter away from the subject. Otherwise, part of the photo will look dark.
- When using the built-in flash, detach any hood attached to the lens. A lens hood will partially obstruct the flash coverage.
- If any of the following lenses attached to the camera, the flash coverage of the built-in flash might be obstructed. Use an external EOS-dedicated Speedlite with these lenses.  
Fast lenses such as the EF 17-35mm f/2.8L USM and EF 28-70mm f/2.8L USM.  
Super telephoto lenses such as the EF 300mm f/2.8L USM and EF 600mm f/4L USM.
- The built-in flash's flash coverage is effective for lenses as short as 28mm. With shorter lenses, the periphery of the photograph will look dark.

## Basic Photography Terms

### Exposure

Exposure occurs when the film is exposed to light. Correct exposure is attained when the film is exposed to a proper amount of light in accordance with the film's sensitivity to light. The correct exposure is adjusted with the camera's shutter speed and aperture.

### Shutter speed

The shutter speed is the length of time the camera's shutter opens to expose the film to the light coming through the lens. The shutter speed is displayed on the camera's LCD panel and in the viewfinder. It ranges from 30 to 1/2000 sec. and bulb.

### Aperture

The aperture setting (f-number) indicates the size of the aperture opening in the lens. It is used to adjust the amount of light striking the film. The aperture setting is displayed on the camera's LCD panel and in the viewfinder. It can range anywhere from 1.0 to 91, depending on the lens attached to the camera.



### ISO film speed

The ISO film speed indicates the film's sensitivity to light. The higher the film speed, the more sensitive the film is. Therefore, ISO 400 and higher-speed films are suited for low-light conditions. The ISO film speed is set in accordance with standards set by the International Standards Organization (ISO).

A film speed from 6 to 6400 can be set with the camera. The film speed is displayed on the LCD panel and in the viewfinder.

## Depth of field

This is the range where acceptable focus can be achieved in front of and behind the point of optimum focus. The smaller the aperture (the larger the f-number), the deeper the depth of field. And the larger the aperture (the smaller the f-number), the shallower the depth of field.

The depth of field is affected as described below:

- (1) A smaller aperture (a larger f-number) increases the depth of field.  
... For example,  $f/8$  obtains a greater depth of field than  $f/4.5$ .
- (2) A lens with a shorter focal length increases the depth of field.  
... A wide-angle lens obtains a deeper depth of field than a telephoto lens at the same shooting distance.
- (3) A longer distance between the camera and subject increases the depth of field.
- (4) Generally, the depth of field behind the point of optimum focus is longer than the depth of field in front of the point of optimum focus.

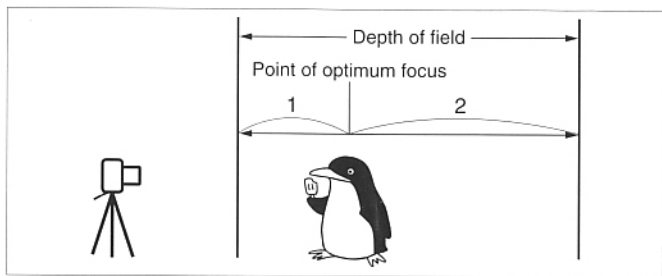

THE IMAGE WAS REMOVED DUE  
TO COPYRIGHT RESTRICTIONS

Aperture set to  $f/2$ .

THE IMAGE WAS REMOVED DUE  
TO COPYRIGHT RESTRICTIONS

Aperture set to  $f/22$ .

# Reference Section

## Feature Availability Table

● : Set automatically. ○ : User selectable.

Command Dial Mode	AF		Focusing Point Selection		Film Advance		Metering Mode			Built-in Flash	
	One-Shot AF	AI Focus	Auto	Manual	Single	Continuous	Evaluative	Center-weighted averaged	Partial	Auto	Manual
		●	●		●		●			●	
	●		●			●	●			●	
	●		●		●		●				
	●		●		●		●			●	
		●	●			●	●				
	●		●		●		●			●	
<b>P</b>		●	○	○		●	●		●*		●
<b>Tv</b>		●	○	○		●	●		●*		●
<b>Av</b>		●	○	○		●	●		●*		●
<b>M</b>		●	○	○		●	●	●	●*		●
<b>A-DEP</b>	●		●		●		●		●*		●

\* Available only while the partial metering button is pressed.

\* In the <M> mode, centerweighted averaging metering is set.

\* AI stands for Artificial Intelligence.

**One-Shot AF** : The exposure setting (shutter speed and aperture) is set when focus is achieved. The picture cannot be taken unless the subject is focused.

**AI Focus AF** : The AF mode is set automatically to suit the subject's movement when the shutter button is pressed.

If the subject is still, the focus is locked when focus is achieved (One-Shot AF). If the subject is moving, focusing is continuous and predictive AF is used so that the subject is in focus at the moment of exposure.

## AF Modes and Film Advance Modes

Film Advance Mode	One-Shot AF	AI Servo AF
<b>Single</b>	The picture cannot be taken until focus is achieved. When focus is achieved, AF lock also takes effect at the same time. The evaluative metering's exposure reading is also locked. (The exposure setting is retained before the picture is taken.)	Autofocusing continues to match the subject's movement. The exposure setting is set at the moment of exposure.
<b>Continuous</b>	The same conditions as above apply during continuous shooting (maximum speed of 1.5 frame per second).	The same conditions as above apply during continuous shooting. Autofocusing continues during continuous shooting (maximum speed of 1.3 frame per second).



## Exposure Warnings



Mode	Sample Warning (Blinking)	Description	Countermeasures
P		The subject is too dark.	Use flash.
		The subject is too bright.	Attach a neutral density filter to the lens to reduce the amount of light.
Tv		The picture will be underexposed.	Turn the <  > dial to set a slower shutter speed.
		The picture will be overexposed.	Turn the <  > dial to set a faster shutter speed.
Av		The picture will be underexposed.	Turn the <  > dial to set a larger aperture.
		The picture will be overexposed.	Turn the <  > dial to set a smaller aperture.
A-DEP		The desired depth of field cannot be obtained.	1) Move away from the subject and try again. 2) If you are using a zoom lens, use the shortest focal length.
		The subject is too dark.	Use flash. The result will be the same as using the < P > mode.
		The subject is too bright.	Attach a neutral density filter to the lens to reduce the amount of light.



The sample warnings apply when a lens having a maximum aperture of f/3.5 and minimum aperture of f/22 is attached to the camera. The maximum and minimum aperture warning displays will differ depending on the lens attached to the camera.

## Troubleshooting Guide

If you have a problem with the camera, first refer to this Troubleshooting Guide.

Problem	Probable Cause	Solution	Page
1. Nothing is displayed on the LCD panel.	The batteries are exhausted.	Replace the batteries with new ones.	16
	The batteries have been installed incorrectly.	Install the batteries correctly.	16
2. The shutter does not release.	The film has not been loaded correctly. (The frame No. is not displayed on the LCD panel.)	Load the film correctly.	20
	Rewound film is still in the camera. (The frame counter on the LCD panel is blank.)	Take out the film cartridge and load a new roll of film.	20
	Focus has not been achieved. (The in-focus indicator in the viewfinder is blinking.)	Press the shutter button halfway until focus is achieved. If focus still cannot be achieved, set the focus mode switch on the lens to <b>MF</b> (or <b>M</b> ) and focus manually with the focusing ring.	19 40
3. The photograph is out of focus.	The focus mode switch on the lens was set to <b>MF</b> (or <b>M</b> ).	Set the focus mode switch on the lens to <b>AF</b> .	18
	The shutter speed was too slow to prevent blur caused by camera shake.	Press the shutter button gently while holding the camera steady or use a faster shutter speed.	19
4. Only  is blinking on the LCD panel.	The battery level is very low.	Replace the batteries with new ones and check that  is displayed on the LCD panel.	17
	For some reason, the camera is not operating properly.	Press the shutter button halfway. The camera should return to normal. * If the  icon is still displayed after you execute the above procedure, the camera needs repair. Take it to the nearest Canon Service Center.	17 Back cover

## Major Accessories (Sold separately)



### Battery Pack BP-200

An external battery pack housing widely-available, size-AA batteries which can power the camera in place of lithium CR2 batteries. It also has a vertical-grip shutter button.

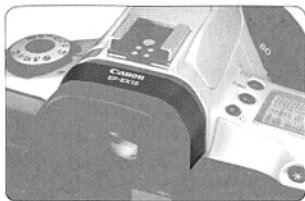

### Eyepiece Extender EP-EX15

When attached to the camera, this eyepiece extender extends the EOS camera's eye relief by 15 mm. The viewfinder magnification also becomes 0.5x.



### Dioptric Correction Lens E

The camera's eyepiece lens is -1 diopter. Attaching a dioptic correction lens E on the eyepiece allows near- or far-sighted users to see the viewfinder clearly without eyeglasses. Ten dioptic correction lenses are available. When choosing a dioptic correction lens, attach it to the eyepiece and look through the viewfinder to see if it suits your vision.

- The number on the dioptic correction lenses indicates the diopter when it is attached to the camera's eyepiece. It is not the diopter of the dioptic correction lens itself.



### Remote Switch RS-60E3

Dedicated cable release for a tripod-mounted camera. Ideal for close-up shots and bulb exposures. Connects to the camera's remote control jack.



## EOS-dedicated EX-Series Speedlites

One example is the Speedlite 380EX (Guide No. 38 at ISO 100 in meters) which attaches to the camera's hot shoe and can provide a large flash output. Another is Speedlite 220EX (Guide No. 22 at ISO 100 in meters) which is more compact.



## Camera Case EH13-L

This dedicated case protects the camera and also accommodates either of the following lenses:

EF 28-80mm f/3.5-5.6 II

EF 28-80mm f/3.5-5.6 V USM



When using an external flash unit, an EOS-dedicated Speedlite is recommended. Using the camera with a flash unit (equipped with electrical contacts on the hot shoe foot), high-voltage flash unit, or flash accessories dedicated to a different brand may result in camera misoperation or malfunction.

## Specifications

### ■Type

Type .....	35mm AF/AE single-lens reflex camera with focal-plane shutter, built-in winder, built-in flash, and auto date back.
Picture size .....	24 mm × 36 mm
Compatible lenses .....	Canon EF lenses
Lens mount .....	Canon EF mount (Fully-electronic control)

### ■Viewfinder

Type .....	Eye-level pentaprism with roof mirror
Picture coverage .....	90% vertical & horizontal
Magnification .....	0.7 × (with 50mm lens focused at infinity).
Standard diopter .....	-1 diopter (18.5mm eye relief)
Focusing screen .....	Fixed, New Laser-matte screen
Viewfinder information .....	① Within the viewfinder screen Focusing points
	② Below viewfinder screen Shutter speed, aperture, exposure level, AE/FE lock, flash-ready indicator, high-speed sync (FP flash), red-eye reduction icon, focusing point indicator, in-focus (AF or MF) indicator
Mirror .....	Quick-return half mirror (no vignetting with EF 600mm f/4L USM lens or a shorter lens)
Depth-of-field preview .....	Provided with depth-of-field preview button.

### ■Exposure Control

Metering system .....	TTL metering at maximum aperture with a 35-zone SPC (silicon photocell).
	① Evaluative metering (linked to 7 focusing points)
	② Partial metering (Automatically set with AE lock, covering approx. 9.5% of viewfinder screen at the center.)
	③ Centerweighted averaging metering (Automatically set in manual exposure mode)
Picture-taking modes .....	① Program AE (shiftable)
	② Shutter speed-priority AE
	③ Aperture-priority AE
	④ Depth-of-field AE
	⑤ Full Auto
	⑥ Five Programmed Image Control modes (Portrait, Landscape, Close-up, Sports, Night Scene)
	⑦ Autoflash exposure: E-TTL program flash AE with EX-series Speedlites, TTL program flash AE with the built-in flash, and A-TTL program flash AE with EZ-series Speedlites.
	⑧ Manual
Camera-shake warning .....	In Basic Zone modes, the shutter speed display blinks (at 2 Hz) if it is slower than the reciprocal of the lens focal length.
Metering range .....	EV 2-20 (at 20°C and normal humidity with a 50mm f/1.4 lens, ISO 100)
ISO Film Speed Range .....	ISO 6-6400 (set automatically for DX-coded film within ISO 25-5000 in 1/3-stop increments)
Exposure compensation .....	① AEB: Up to ±2 stops in 1/2-stop increments in the following sequence: Correct exposure, underexposure, and overexposure.
	② Manual exposure compensation: ±2 stops in 1/2-stop increments.

# Reference Section

- AE lock.....① Auto AE lock  
Takes effect when focus is achieved in the One-Shot AF and evaluative metering modes.  
② With AE lock button  
Partial metering mode is set automatically with the AE lock button.  
Multiple exposures: Up to 9 multiple exposures.

## ■Autofocus

- AF control .....TTL-SIR with CMOS sensor  
Focusing points.....7 (II±II)  
AF working range.....EV 1-18 (at ISO 100)  
Focusing point selection ...① Automatic by the camera  
② Manual  
Focusing modes ① One-Shot AF: AF locks when focus is achieved. Shutter can be released only when focus is achieved.  
② AI Focus AF: If the subject focused in the One-Shot AF mode starts moving forward or back, the mode switches to AI Servo AF automatically.  
③ Manual focusing: Enabled by setting the lens' focus mode switch to MF (or M) and turning the focusing ring.  
AF-assist beam.....When necessary, the AF-assist light flashes intermittently automatically.

## ■Shutter

- Type .....Vertical-travel, focal-plane shutter with all speeds electronically-controlled.  
Shutter speeds.....30 to 1/2000 sec. (in half-stop increments) and bulb, X-sync at 1/90 sec.  
Shutter release .....Soft-touch, electro-magnetic release.  
Self-timer .....Electronically-controlled for 10-sec. delay.

## ■Film Transport

- Film loading .....Automatic with prewind system  
Film advance .....Automatic. ① Single-frame ② Continuous (Approx. 1.5 frame per sec. maximum)  
Film rewind .....① Automatic rewind at the end of the roll.  
② Midroll rewind enabled with midroll rewind button.  
Film rewind noise level .....Approx. 60 dB

## ■Built-in flash

- Type .....Retractable TTL automatic flash (serially controlled)  
① Guide No. 12 (at ISO 100 in meters)  
② Recycling time: Approx. 2 sec.  
③ Flash coverage: 28mm lens covered.  
④ Flash metering: TTL autoflash

### Other Specifications

Flash contacts.....	X-sync for direct connection on hot shoe.
External Speedlite compatibility...	Compatible with E-TTL/A-TTL/TTL autoflash systems.
Red-eye reduction .....	Built-in lamp which can be enabled/disabled in all picture-taking modes.
Remote contro .....	Socket provided for optional Remote Switch RS-60E3.
Power source .....	Two CR2 lithium batteries
Battery service life .....	Number of 24-exposure rolls with 50% flash use: Approx. 24 rolls at 20°C and approx. 16 rolls at -10°C.
Battery check .....	One of four battery levels is displayed when the Command Dial is released from L.
Dimensions .....	140 (W) × 90 (H) × 58.5 (D) mm / 5.51 (W) × 3.54 (H) × 2.30 (D) in.
Weight (body only).....	335 g / 11.82 oz (QD model: +15 g / +0.53 oz)

Lens		EF 28-80mm F/3.5-5.6 V USM	EF 28-80mm F/3.5-5.6 II	EF 35-80mm F/4-5.6 III
Angle of view	Diagonal extent	75° - 30'	75° - 30'	63° - 30'
	Vertical extent	46° - 17'	46° - 17'	38° - 17'
	Horizontal extent	65° - 25°	65° - 25°	54° - 25°
Lens construction (elements/groups)		10/10	10/10	8/8
Min. aperture		f/22-f/38	f/22-f/38	f/22-f/32
Focusing distance range		0.38 m - infinity	0.38 m - infinity	0.4 m - infinity
Max. magnification (Wide/Tele)		0.10/0.26×	0.10/0.26×	0.11/0.23×
Filter size and attachable quantity		58mm, 1	58mm, 1	52mm, 1
Max. diameter × length		66.4 × 71.2 mm	66.4 × 71.2 mm	65 × 63.5 mm
Weight		200 g	200 g	175 g

\* All specifications have been obtained through Canon's test methods.

\* Product specifications and physical appearance are subject to change without notice.

<b>A</b>	
Accessories .....	67
AEB .....	53
AF Modes and Film Advance Modes .....	64
AF-Assist Lamp .....	26
AI Servo AF .....	64
AI Focus AF .....	64
Aperture .....	62
Av Aperture-Priority AE .....	46
Auto Exposure Bracketing (AEB) .....	53
Autofocus failure (Switching to Manual Focus) .....	40
<b>A-DEP</b> Automatic Depth-of-Field AE .....	50
<b>B</b>	
Basic Zone .....	14
Batteries	
Installation .....	16
Level check .....	17
Replacement for quartz date back .....	36
Battery Service Life .....	17
Beeper, silencing .....	54
Built-in Flash Range .....	60
Built-in flash, using .....	60
Bulb Exposures .....	55
<b>C</b>	
Center-weighted averaged metering .....	41
Close-up Mode .....	30
Command Dial .....	14
Continuous shooting .....	64
Creative Zone .....	14
<b>D</b>	
Date/time	
Imprinting .....	35
Changing .....	36
Depth of field .....	63
Depth-of-field Preview .....	47
<b>E</b>	
Evaluative metering .....	41
External EOS-dedicated Speedlites .....	59
Exposure .....	62
Exposure Compensation .....	52
Exposure Warnings .....	65
Eyepiece Cover .....	34
<b>F</b>	
Feature Availability Table .....	64
Film	
Loading .....	20
Removing .....	21
Midroll Rewind .....	21
Setting film speed .....	57
Film Speed .....	62
Flash, automatic firing of .....	26
Flash Sync Speeds and Flash Apertures .....	61
Focusing points	
Focusing off-center subjects .....	39
Selection .....	38
<input type="checkbox"/> Full Auto Mode .....	24
<b>H</b>	
Holding the Camera .....	22
<b>L</b>	
<b>L</b> Landscape Mode .....	29
LCD Panel .....	12
Lens	
Specifications .....	71
Mounting .....	18
Detaching .....	18
<b>M</b>	
<b>M</b> Manual Exposure .....	48
Manual Focusing .....	40
<input type="checkbox"/> Multiple Exposures .....	56
<b>N</b>	
Nomenclature .....	10
<b>O</b>	
One-Shot AF .....	64
<b>P</b>	
<b>P</b> and <input type="checkbox"/> , Differences Between .....	43
Partial metering .....	41
* Partial Metering Using AE Lock .....	51
<input type="checkbox"/> Portrait Mode .....	28
<b>P</b> Program AE .....	42
Program Shift .....	43
Programmed Image Control Modes .....	14
<b>Q</b>	
Quick Start Guide .....	8
<b>R</b>	
<input checked="" type="checkbox"/> Red-eye Reduction .....	27
Remote Switch (Sold separately), Using .....	58
<b>S</b>	
<input checked="" type="checkbox"/> Self-timer .....	33
<input checked="" type="checkbox"/> Shooting Night Scenes .....	32
Shutter button	
Halfway pressing .....	19
Complete pressing .....	19
Shutter speed .....	62
<b>Tv</b> Shutter-Speed Priority AE .....	44
<input checked="" type="checkbox"/> Silencing the Beeper .....	54



Single and Continuous Shooting .....	26
Strap, how to attach .....	15
☞ Sports Mode .....	31
Specifications .....	69
<b>T</b>	
Troubleshooting Guide .....	66
<b>V</b>	
Viewfinder Information .....	13

This device complies with Part 15 of the FCC Rules. Operation is subject to the following two conditions: (1) This device may not cause harmful interference, and (2) this device must accept any interference received, including interference that may cause undesired operation.

Do not make any changes or modifications to the equipment unless otherwise specified in the instructions. If such changes or modifications should be made, you could be required to stop operation of the equipment.

This equipment has been tested and found to comply with the limits for a class B digital device, pursuant to part 15 of the FCC Rules. These limits are designed to provide reasonable protection against harmful interference in a residential installation. This equipment generates, uses and can radiate radio frequency energy and, if not installed and used in accordance with the instructions, may cause harmful interference to radio communications.

However, there is no guarantee that interference will not occur in a particular installation. If this equipment does cause harmful interference to radio or television reception, which can be determined by turning the equipment off and on, the user is encouraged to try to correct the interference by one or more of the following measures:

- Reorient or relocate the receiving antenna.
- Increase the separation between the equipment and receiver.
- Consult the dealer or an experienced radio/TV technician for help.

This digital apparatus does not exceed the Class B limits for radio noise emissions from digital apparatus as set out in the interference-causing equipment standard entitled "Digital Apparatus", ICES-003 of the Industry Canada.



The CE Mark is a Directive conformity mark of the European Community (EC)



THE IMAGE WAS REMOVED DUE  
TO COPYRIGHT RESTRICTIONS

# Canon

Company information that is no longer current has been removed.  
If you have any questions regarding this model  
and are calling from the USA, please call 1 800 OK CANON.